



Current transformers  
DM0T0080

Product designation

Product type designation

Auxiliary supply  $U_s$

Operational frequency

min	Hz	50
max	Hz	60

Current inputs

Primary current  $I_{pn}$  (/5)

A 80

Secondary output current

A 5

Overload withstand  $I_{pn}$

% 120

Burden

cl. 1 VA 1.5

Insulations

Rated insulation voltage  $U_i$  IEC/EN

V 720

IEC rated short-time thermal current  $I_{th}$

$I_{th}$  for s 40...60

IEC rated dynamic current  $I_{dyn}$

$I_{th}$  for s 2.5

Insulation dry type

Class E

Mechanical features

Terminals type

Screw

Fixing

DIN rail or by  
Screw

Weight

g 200

Ambient conditions

Temperature

Operating temperature

min	°C	-25
max	°C	+50

Storage temperature

min	°C	-40
max	°C	+80

Relative humidity

% 90

Protection degree

IP30

Dimensions

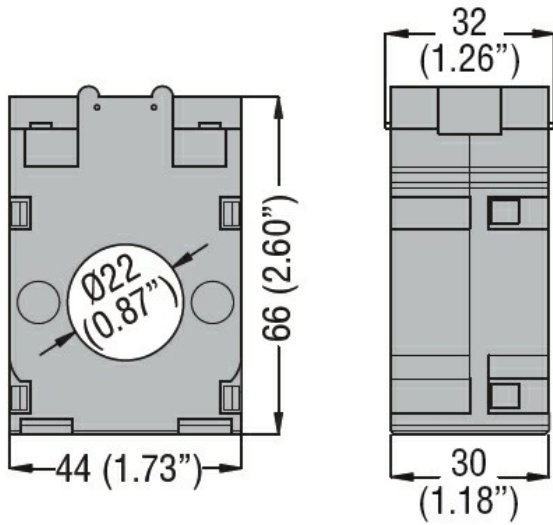

**Certifications and compliance**

Compliance

IEC/EN/BS 61869-1

IEC/EN/BS 61869-2

Certificates

EAC

GOST

**ETIM classification**

ETIM 8.0

EC002048 -  
 Current  
 transformer